









SECTION 6

OVERHEAD BOLTED CONNECTORS

Bolted overhead fittings are versatile in several ways. Their basic design offers a range taking capability, no special tooling is required to effect a reliable connection, and each fitting may be re-used without loss of efficiency. A variety of hardware is available, including galvanised steel bolts and nuts as standard equipment.

CONNECTORS	STYLE	CONDUCTOR RANGE	PAGE
	GP Overhead Line Tap	6-19mm	52
	Disconnect Tee Clamp	7-19mm	52
	Service Connector	15mm	53
	Line Stirrup Clamp	6-19mm	53
	Parallel Groove Connector	12-19mm	54
	Bi-Metal PG Clamp	2.7-21.0mm	54
	Aluminium PG Clamp Double Bolt	5.1-20.2mm	55
	Copper PG Clamp Single Bolt	1.8-9.0mm	55
	Copper PG Clamp Double Bolt	1.8-15.7mm	55
	Split Bolt Connector	16-185mm ²	56
	Electrical Jointing Compound	Light Brown	53

GENERAL PURPOSE OVERHEAD LINE TAP CONNECTOR

- General purpose for bare overhead conductors applications where tap is required to carry full line current
 - Combined bolted and compression connection technology
 - Special aluminium alloy body for strength and ductility
 - Integral belleville washers • Stainless Steel fasteners
- Captive nut • Contact Surfaces pre-coated with Utilux No.3G jointing compound

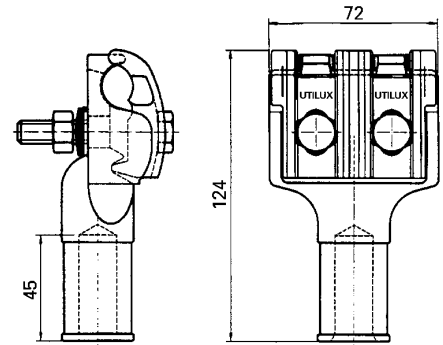

CAT NO.	DESCRIPTION	LINE CONDUCTOR RANGE (COND. OD)	Ø I.D. (XXY)
LTGSXXY	Line Tap Connector	6-19mm	Bore dimension ϕ ID eg. for a bore of 17.5mm, xxy = 175

DISCONNECT TEE CLAMP

- All aluminium • Accepts Aluminium single hole crimp lugs

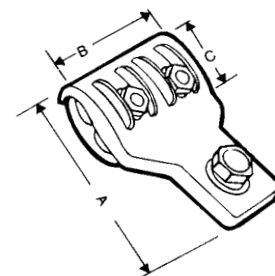

CAT NO.	CONDUCTOR RANGE O.D.	DIMENSIONS mm			BOLT DIA.	SET SCREW
		A	B	C		
TCDA19	7-19	120.0	75.0	42.0	M10 x 50	M12 X 40

Made to minimum order only

SERVICE CONNECTOR

- Cast high strength aluminium alloy connector identified with Catalogue No. and cable range
- Available in two configurations

TYPE 1. Tinned split bolt clamp compression crimped into connector body for direct service connection

TYPE 2. Two connectors joined by a customer nominated length of tinned 7/.104 (imperial) copper conductor (Standard is 254mm) • Available with stainless steel hardware on application

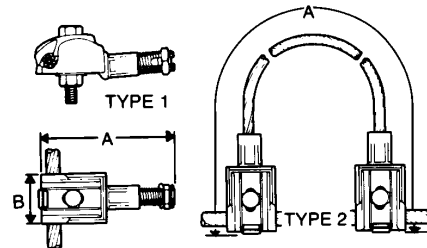

BT SERIES	CAT NO.	CONDUCTOR RANGE O.D.	DIMENSIONS mm		BOLT DIA	
	BT-PP SERIES		MAIN	TAP		A
*BT2-1	BT2-1PP	15	6	111.1	40.5	M10 X 50
BT2-2	BT2-2PP	15	-	412.8	40.5	M10 X 50

*Accepts 6mm OD cable from 1 to 3 times
BT-PP series contain grease

LINE STIRRUP CLAMP

- Cast high strength aluminium alloy, heat treated
 - Individually packed in plastic bags and identified with Catalogue No. and cable range
 - Tinned stranded copper stirrup is compression crimped into the connector body
 - Incorporates anodised aluminium nuts and bolts
 - Bolts are located in retaining channels to prevent slip during installation
 - Features the combination of a parallel groove clamp and a line stirrup clamp, enabling copper taps to be made at bridging locations.
- Application – connection of copper conductors to aluminium mains
- LS-PP Series pre-packed with jointing compound
 - LS-PPSS Series pre-packed with jointing compound and with Stainless Steel hardware

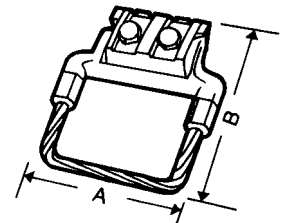

LS SERIES	CAT NO.	CONDUCTOR RANGE O.D.	DIMENSIONS mm		BOLT DIA	
	LS-PP SERIES		LS-PPSS SERIES	MAIN AL OR ACSR		A
LS01	LS01PP	LS01PPSS	6-19	76.2	146.1	M10 x 50
LS02	LS02PP	LS02PPSS	6-19	120.7	146.1	M10 x 50



ELECTRICAL JOINTING COMPOUND

- Seals out air and moisture, therefore minimising oxidation or corrosion and maximising conductivity
- High melt point grease

CAT NO.	NO.	APPLICATION	PART	COLOUR	TUBE SIZE
H2398	1	For bolted palm connections	No Grit	Light Brown (honey colour)	250g

PARALLEL GROOVE CONNECTORS

- Cast high strength aluminium alloy, heat treated
- Individually packed in plastic bags and identified with Catalogue No. and cable range
- Anodised aluminium nuts and bolts of sufficient length to allow installation without disassembling connector
 - Bolts are located in retaining channels to prevent slip during installation
 - Suitable for the following conductors: ACSR, AAC – conventional or smooth body
- Designed specifically for overhead power line applications
 - PG-PP Series pre-packed with jointing compound
 - Stainless steel, electro-tinned or galvanised bolts available for approved minimum order quantities

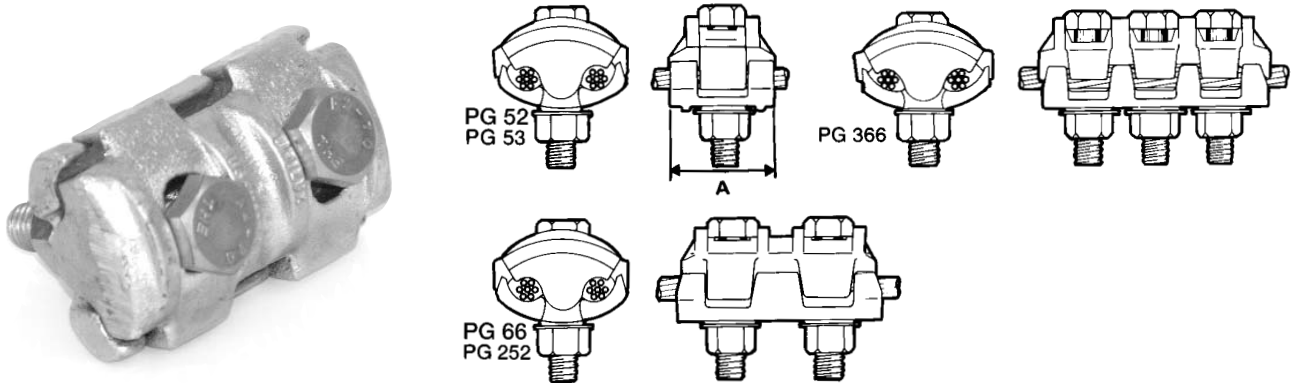

PG SERIES	CAT NO. PG-PP SERIES	NO. BOLTS	CONDUCTOR O.D.		LENGTH A mm	BOLT
			MAIN (MAX O.D.)	TAP (MIN O.D.)		
PG52	PG52PP	1	12	3	37	M10 x 50
PG53	PG53PP	1	19	9	55	M12 x 65
PG66	PG66PP	2	19	9	92	M12 x 65
PG252	PG252PP	2	12	3	72	M10 x 50
PG366	PG366PP	3	19	9	111	M12 x 65

BI-METAL PG CLAMPS - DOUBLE & TRIPLE BOLT

- For aluminium main conductors and copper tap-off conductors
- Pressure pad, hex. head screws and nuts
- Clamp body and pressure pad is made of high strength aluminium alloy with compressed bi-metallic sheet for copper tap-off
- Screws: DIN 933 – Steel, grade 8.8 hot-dip galvanised
- Nuts: DIN 934 –Steel, grade 8, hot-dip galvanised



CAT NO.	CONDUCTOR CROSS SECTION		CONDUCTOR RANGE O.D.		LENGTH A mm	BOLT
	ALUMINIUM mm ²	COPPER mm ²	ALUMINIUM mm ²	COPPER mm ²		
WG3909	16-70	6-50	5.1 to 11.7	2.7 to 9.0	40	2 x M8 x 40
WG3911	12-150	10-95	6.3 to 15.7	4.1 to 12.5	49	2 x M8 x 45
WG3913	35-185	35-185	7.5 to 17.5	7.5 to 17.5	65	2 x M10 x 60
WG3915	95-240	70-185	12.5 to 21.0	10.5 to 17.6	105	3 x M10 x 60

SPLIT BOLT CONNECTORS

- For tapping or joining aerial hard drawn or insulated copper conductors
- Made from hard grade, high conductivity brass
- Captive saddle applies distributed pressure to conductors to ESAA specifications

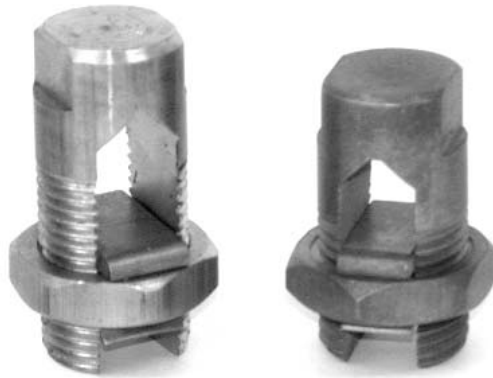

NATURAL BRASS	CAT NO.		ESSA TYPE	MAX CONDUCTOR SIZE AREA mm ²	OVERALL DIA.	SLOT WIDTH mm
		ELECTRO TINNED				
SB22		SB22ET	A	16	5.10	5.3
SB24		SB24ET	B	35	7.65	8.3
SB25		SB25ET	C	70	10.70	10.9
SB26		SB26ET	D	95	12.90	12.9
SB28		SB28ET	E	185	18.50	18.5

